

CERTIFIRE certificated fire doors available from stock or manufactured to order within 3-5 days

Our trained staff are able to cut apertures into fire doors which meet all relevant CERTIFIRE standards. We can cut apertures in both John Carr or Premdor fire doors.

You can order your fire door with an aperture to your specification direct from the manufacturer but this can take up to 4-5 weeks.

We can offer you a speedier service, using popular fire doors from stock, with an aperture to your specification normally within 3-5 working days.

Apertures cut to your specification



Design: 1G Design: 3G Design: 5G Design: 7G



Design: 8G Design: 10G Design: 16G Design: 18G



Design: 19G



- Factory assembled fire door set**
- Fire door leaf supplied separately**
- Glass opening prepared and glazed by a CERTIFIRE manufacturer other than the "Prime" Fire Door Manufacturer"**
- Glass cut and prepared ready for glazing by FIRAS accredited installer**
- Fire door frame sold or supplied separately**

Always check the CERTIFIRE label!

CF 999 A456789 Fire Door Manufacturer
CAF 000 A123456 Company Name
CAF 000 C345678 Company Name
CAF 000 B234567 Company Name
CAF 000 987654 Company Name

CERTIFIRE labels: **CERTIFIED FIRE DOOR FD 30**, **CERTIFIED GLAZED APERTURE**, **CERTIFIED FIRE DOOR FRAME**, **CERTIFIED GLASS OPENING**

KB Kent Blaxill Timber & Joinery

Kent Blaxill terms and conditions of sale apply. Goods and services subject to availability. Delivery service subject to availability, within our distribution area. All goods shown are available from stock at our Colchester branch, goods may not be stocked by all branches but are available through our branch network.
 Kent Blaxill & Co. Ltd, 129-139 Layer Rd, Colchester CO2 9JY.
 Co. Reg. Nos. 83667 (England) V.A.T. Reg No 102 3797 90

<p>BRAINTREE Unit 8, Braintree Trade Centre, Century Drive, Braintree CM7 3GZ ☎ 01376 335999 Fax: 01376 335990</p>	<p>IPSWICH Holywells Rd, Ipswich IP3 0DL ☎ 01473 217454 F: 01473 288868</p>	<p>NORWICH Marriott Close, Off Heigham Street, Norwich, NR2 4UX ☎ 01603 628973 Fax: 01603 667693</p>
<p>BURY ST EDMUNDS Dettingen Way, Bury St Edmunds IP33 3TX ☎ 01284 762401 Fax: 01284 700202</p>	<p>KIRBY CROSS Claire Road, Kirby Cross CO13 0LY ☎ 01255 679161 Fax: 01255 851001</p>	<p>SUDBURY Martins Rd, Sudbury CO10 2FT ☎ 01787 372241 Fax: 01787 310960</p>
<p>MELTON Wilford Bridge Spur, Melton, Woodbridge, Suffolk IP12 1RB ☎ 01394 384255 Fax: 01394 382312</p>	<p>You can visit www.kentblaxill.co.uk or email sales@kentblaxill.co.uk</p>	



FSC
www.fsc.org
FSC® C011137

PEFC
PEFC/16-37-886

The mark of responsible forestry

Chain of Custody
Wherever possible we sell timber products from sustainable sources in line with FSC® & PEFC rules.



Timber & Joinery Products and Services

www.kentblaxill.co.uk



- Timber treatment on site**
PSE or Sawn timber treated to your specification. We can treat timber for above ground applications with a clear treatment.
- Stress grading**
TRADA registered stress graders on site.

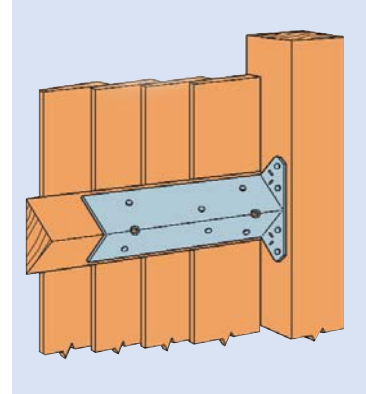

- Joinery Specialists**
Jeldwen & Premdor Windows & Doors
- Staircases**
Free site surveys & quotes.
- Velux Windows**
- C.L.S. Timber**
- Featheredge**
- Railway Sleepers**



- Large stocks of redwood PSE & hardwood PSE**
- C16 and C24 Sawn timber**
- Timber milling**
Re-saw & Crosscut to specification. Regularising of floor joists and roof plates



- Comprehensive range of sheet materials from stock**
- Panel Saw**
A sheet cutting service is offered at our Colchester & Bury branches.
- Richard Burbidge**
Flooring & Mouldings

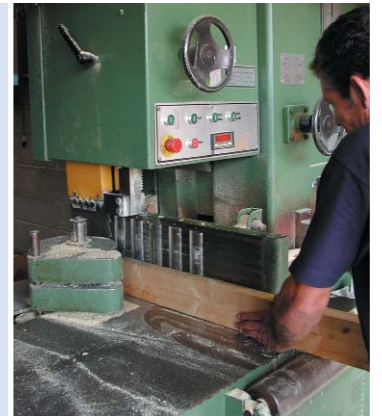

Matching

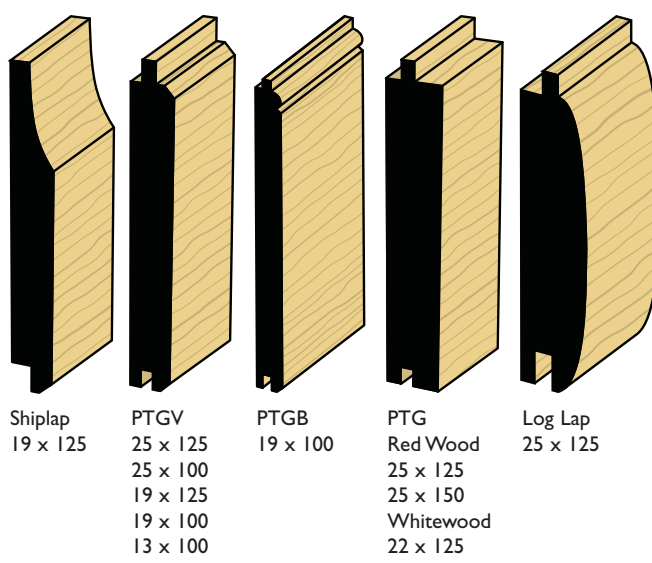

Shiplap 19 x 125
 PTGV 25 x 125, 25 x 100, 19 x 125, 19 x 100, 13 x 100
 PTGB 19 x 100
 PTG Red Wood 25 x 125, 25 x 150, Whitewood 22 x 125
 Log Lap 25 x 125

Skirtings

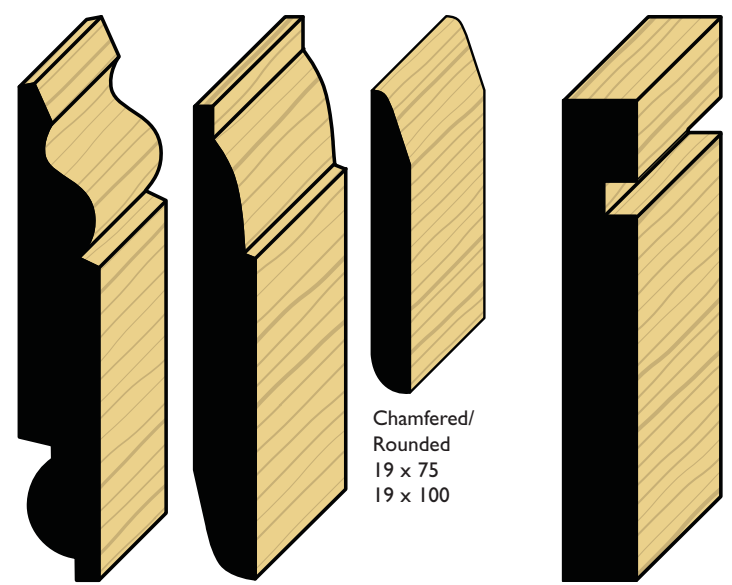

Torus/OG 25 x 150, 25 x 175
 Ovolo/Chamfered 25 x 150
 Grooved 25 x 175

Fascia

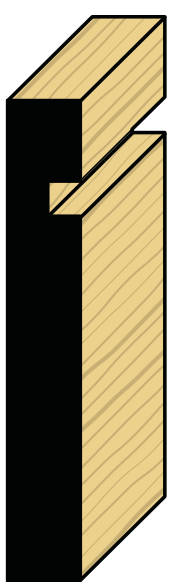

Grooved 25 x 175

Mouldings

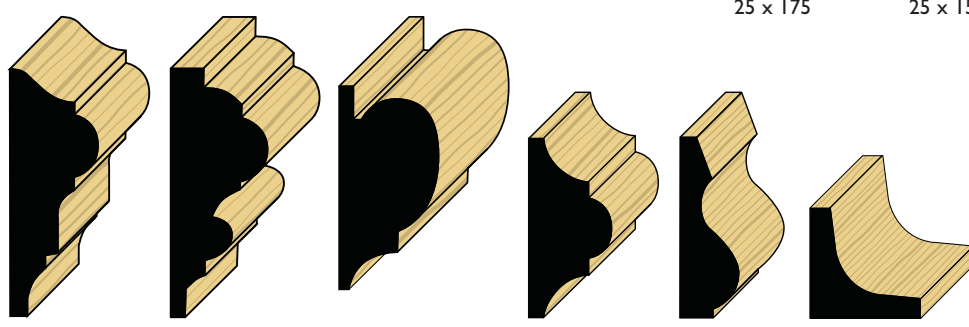

KBI Dado 25 x 63
 KB2 Dado 25 x 63
 KB3 Picture Rail 25 x 50
 Astragal 19 x 38
 Panel Mould 13 x 25, 16 x 38
 Scotia 25 x 25, 38 x 38

Architrave

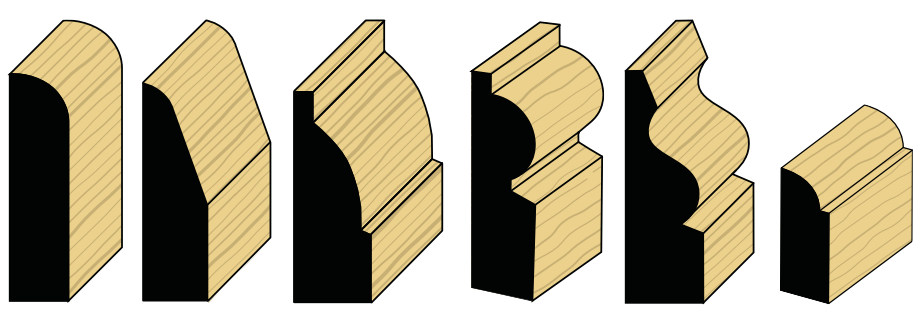

Rounded 19 x 50
 Chamfered 19 x 50
 Ovolo 25 x 63
 Torus 25 x 75
 Ogee 25 x 50, 25 x 63, 25 x 75
 Ovolo Door Stop 16 x 38

Window & Door Sections

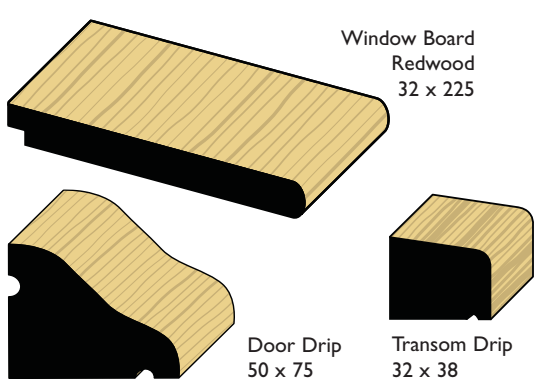

Window Board Redwood 32 x 225
 Door Drip 50 x 75
 Transom Drip 32 x 38

Beads

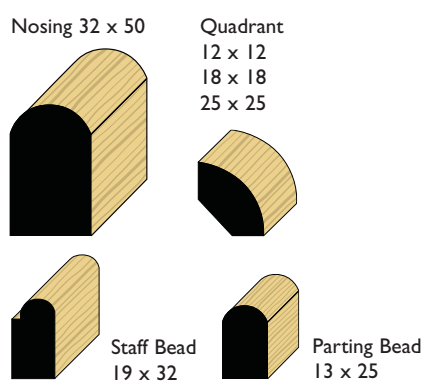

Nosing 32 x 50
 Quadrant 12 x 12, 18 x 18, 25 x 25
 Staff Bead 19 x 32
 Parting Bead 13 x 25

PSE Sizes

	32 x 100	75 x 75
	32 x 150	75 x 100
	32 x 175	100 x 100
Redwood PSE (mm)	25 x 38	
	25 x 50	
	25 x 75	
	25 x 100	
	25 x 125	
	25 x 150	
	25 x 175	
	25 x 200	
	25 x 225	
	32 x 32	
	32 x 38	
	32 x 50	
Whitewood PSE (mm)		for door linings
		32 x 115
		32 x 138

Hand Rails

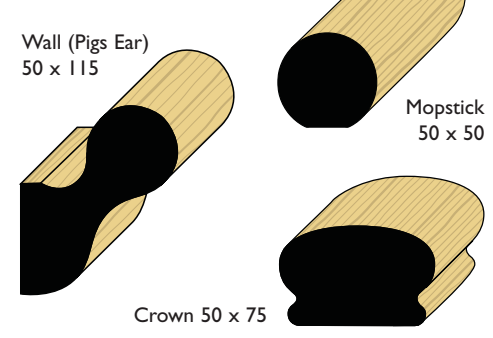

Wall (Pigs Ear) 50 x 115
 Mopstick 50 x 50
 Crown 50 x 75

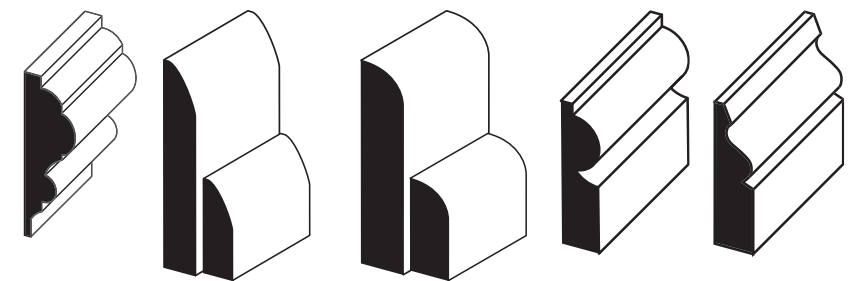

Dado Rail 18 x 58
 Chamfered Skirting 14.5 x 70, 14.5 x 95, Architrave 14.5 x 45
 Rounded Skirting 14.5 x 70, 14.5 x 95, Architrave 14.5 x 45
 Torus Architrave 18 x 70
 Ogee Architrave 18 x 58, 18 x 70
 Torus Skirting 18 x 145
 Ogee Skirting 18 x 145

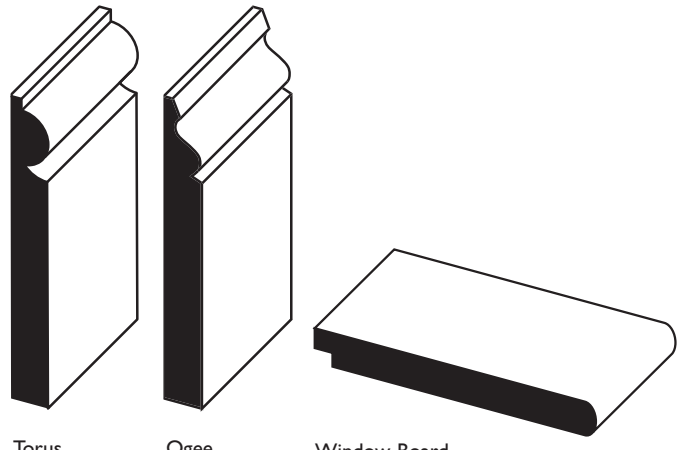

Torus Skirting 18 x 145
 Ogee Skirting 18 x 145
 Window Board 25 x 220, 25 x 244, 25 x 296

KB Kent Blaxill **Featheredge Fencing & Posts**

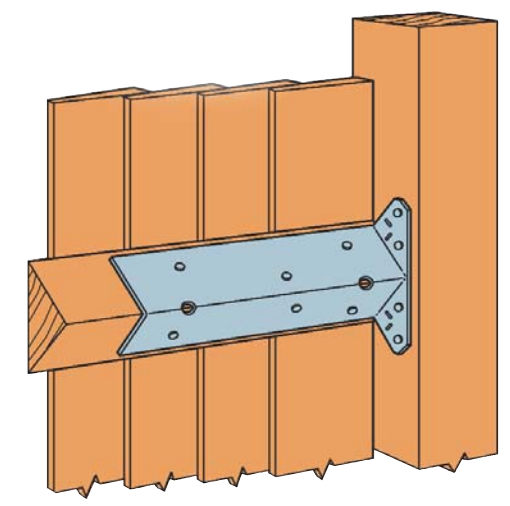

Brown Treated Featheredge	22mm x 100mm 1.65m & 1.80m	Brown Cant Rail	EX 47mm x 125mm 2.40m & 3.00m
	22mm x 125mm 1.65m & 1.80m		
	22mm x 150mm 1.65m, 1.80m & 4.80m	Brown Treated Arris Rail	EX 75mm x 75mm 2.40m & 3.00m
	22mm x 175mm 1.80m & 4.80m		
Brown Treated Gravel Boards	22mm x 150mm 1.829m, 2.40m & 3.00m	Untreated Featheredge	22mm x 150mm 4.80m
			22mm x 175mm 4.80m
Green Treated Gravel Boards	R4GR 6"		32mm x 175mm 4.80m
		Black Painted Featheredge	32mm x 175mm 4.80m

KB Kent Blaxill **Hardwood** Sizes stated are nominal (Ex)

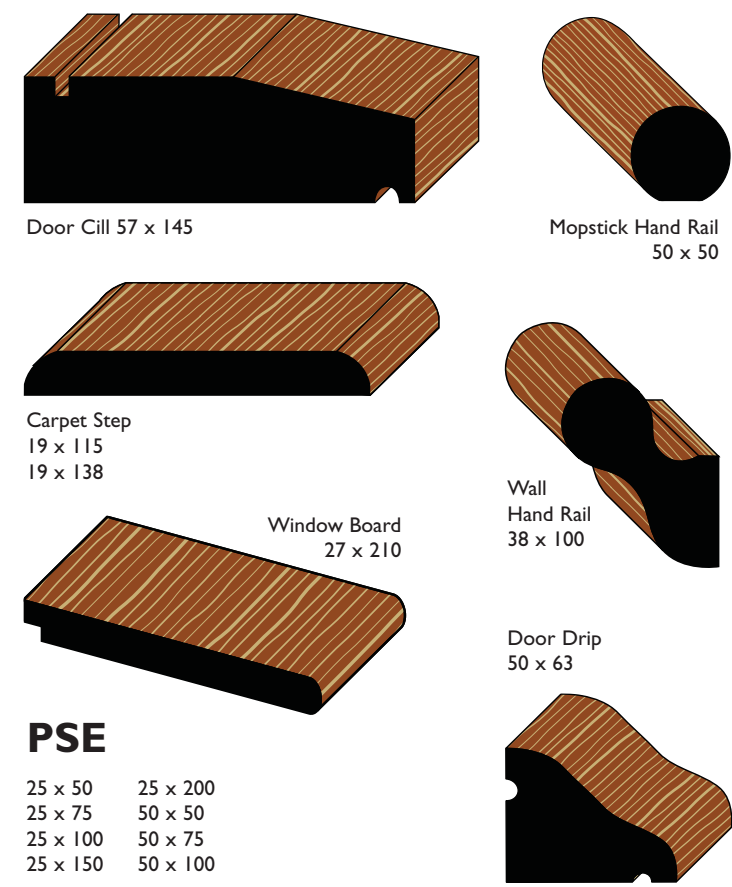

Door Cill 57 x 145
 Carpet Step 19 x 115, 19 x 138
 Window Board 27 x 210
 Wall Hand Rail 38 x 100
 Door Drip 50 x 63
 Mopstick Hand Rail 50 x 50

PSE

25 x 50	25 x 200
25 x 75	50 x 50
25 x 100	50 x 75
25 x 150	50 x 100

KB Kent Blaxill **Decking** Tanalith treated

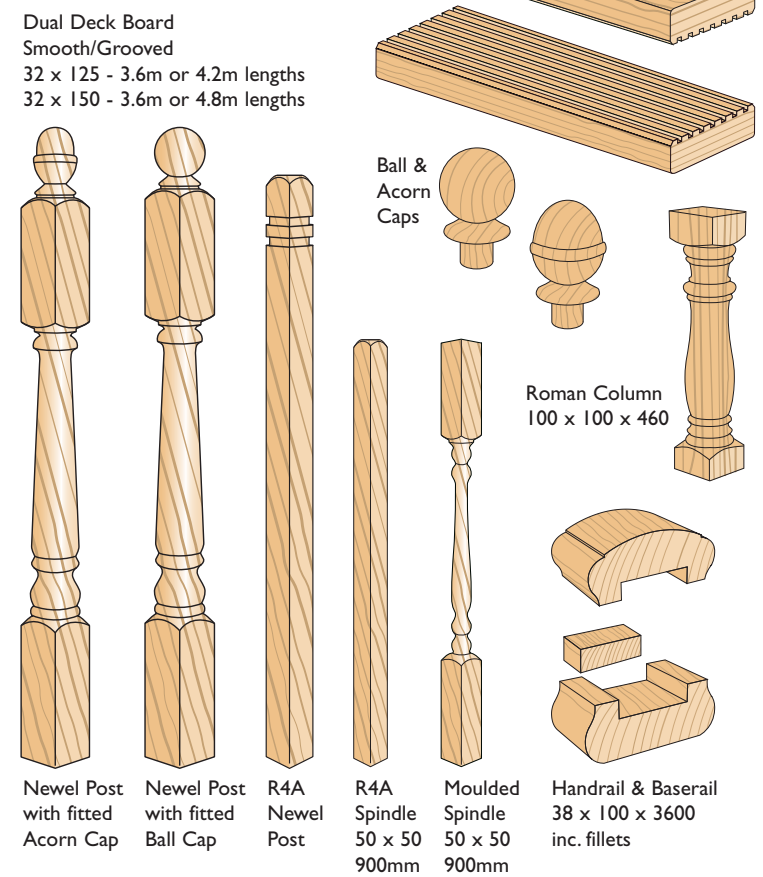

Dual Deck Board Smooth/Grooved 32 x 125 - 3.6m or 4.2m lengths, 32 x 150 - 3.6m or 4.8m lengths
 Ball & Acorn Caps
 Roman Column 100 x 100 x 460
 Newel Post with fitted Acorn Cap
 Newel Post with fitted Ball Cap
 R4A Newel Post
 R4A Spindle 50 x 50, 900mm
 Moulded Spindle 50 x 50, 900mm
 Handrail & Baserail 38 x 100 x 3600 inc. fillets